

## Description:

This Dual N-Channel MOSFET uses advanced trench technology and design to provide excellent  $R_{DS(ON)}$  with low gate charge.

It can be used in a wide variety of applications.

## Features:

- 1)  $V_{DS}=60V, I_D=4.5A, R_{DS(ON)} < 36m\Omega @ V_{GS}=10V$
- 2) Low gate charge.
- 3) Green device available.
- 4) Advanced high cell density trench technology for ultra low  $R_{DS(ON)}$ .
- 5) Excellent package for good heat dissipation.

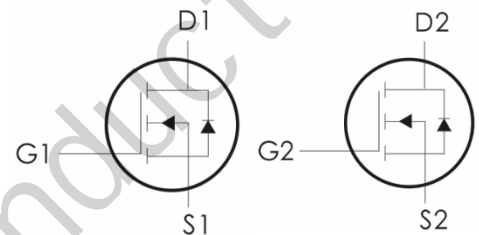
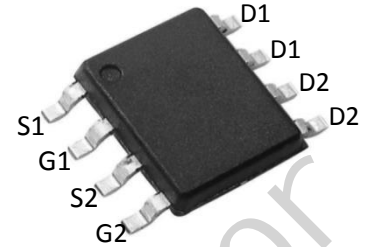

## Absolute Maximum Ratings: ( $T_A=25^\circ C$ unless otherwise noted)

Symbol	Parameter	Ratings	Units
$V_{DS}$	Drain-Source Voltage	60	V
$V_{GS}$	Gate-Source Voltage	$\pm 20$	V
$I_D$	Continuous Drain Current - $T_A=25^\circ C^1$	4.5	A
	Continuous Drain Current - $T_A=70^\circ C^1$	3.5	
$I_{DM}$	Drain Current-Pulsed <sup>2</sup>	18	A
$E_{AS}$	Single Pulse Avalanche Energy <sup>3</sup>	22	mJ
$I_{AS}$	Avalanche Current	21	A
$P_D$	Power Dissipation <sup>4</sup>	1.5	W
$T_J, T_{STG}$	Operating and Storage Junction Temperature Range	-55 to +150	$^\circ C$

## Thermal Characteristics:

Symbol	Parameter	Max	Units
$R_{\theta JA}$	Thermal Resistance, Junction to Ambient <sup>1</sup>	85	$^\circ C/W$

### Thermal Characteristics:

Symbol	Parameter	Max	Units
$R_{\theta JA}$	Thermal Resistance, Junction to Ambient <sup>1</sup>	85	°C/W
$R_{\theta JC}$	Thermal Resistance Junction-Case <sup>1</sup>	25	°C/W

### Electrical Characteristics: ( $T_C=25^\circ\text{C}$ unless otherwise noted)

Symbol	Parameter	Conditions	Min	Typ	Max	Units
<b>Off Characteristics</b>						
$BV_{DSS}$	Drain-Source Breakdown Voltage	$V_{GS}=0V, I_D=250 \mu A$	60	---	---	V
$I_{DSS}$	Zero Gate Voltage Drain Current	$V_{GS}=0V, V_{DS}=48V, T_J=25^\circ\text{C}$	---	---	1	$\mu A$
		$V_{GS}=0V, V_{DS}=48V, T_J=55^\circ\text{C}$	---	---	5	$\mu A$
$I_{GSS}$	Gate-Source Leakage Current	$V_{GS}=\pm 20V, V_{DS}=0A$	---	---	$\pm 100$	nA
<b>On Characteristics</b>						
$V_{GS(th)}$	GATE-Source Threshold Voltage	$V_{GS}=V_{DS}, I_D=250 \mu A$	1	---	2.5	V
$R_{DS(on)}$	Drain-Source On Resistance	$V_{GS}=10V, I_D=4A$	---	30	36	m $\Omega$
		$V_{GS}=4.5V, I_D=3A$	---	34	45	
$G_{FS}$	Forward Transconductance	$V_{DS}=5V, I_D=4A$	---	28.3	---	S
<b>Dynamic Characteristics</b>						
$C_{iss}$	Input Capacitance	$V_{DS}=15V, V_{GS}=0V, f=1\text{MHz}$	---	1020	---	pF
$C_{oss}$	Output Capacitance		---	60	---	
$C_{rss}$	Reverse Transfer Capacitance		---	45	---	
<b>Switching Characteristics</b>						
$t_{d(on)}$	Turn-On Delay Time	$V_{DD}=30V, I_D=4A$ $R_G=3.3 \Omega, V_{GS}=10V,$	---	3	---	ns
$t_r$	Rise Time		---	34	---	ns
$t_{d(off)}$	Turn-Off Delay Time		---	23	---	ns
$t_f$	Fall Time		---	6	---	ns
$Q_g$	Total Gate Charge		$V_{GS}=10V, V_{DS}=48V,$	---	19	---
$Q_{gs}$	Gate-Source Charge	$I_D=4A$	---	2.6	---	nC

<b>Q<sub>gd</sub></b>	Gate-Drain "Miller" Charge		---	4.1	---	nC
<b>R<sub>G</sub></b>	Gate Resistance	V <sub>DS</sub> =0V, V <sub>GS</sub> =0V, f=1MHz	---	2.5	---	Ω
<b>Drain-Source Diode Characteristics</b>						
<b>V<sub>SD</sub></b>	Source-Drain Diode Forward Voltage <sup>2</sup>	V <sub>GS</sub> =0V, I <sub>S</sub> =1A, T <sub>J</sub> =25°C	---	---	1.2	V
<b>I<sub>S</sub></b>	Continuous Source Current <sup>1,5</sup>	V <sub>G</sub> =V <sub>D</sub> =0V, Force Current	---	---	4.5	A
<b>I<sub>SM</sub></b>	Pulsed Source Current <sup>2,5</sup>		---	---	18	A
<b>T<sub>rr</sub></b>	Reverse Recovery Time	I <sub>F</sub> =4A, di/dt=100A/μs, T <sub>J</sub> =25°C	---	12.1	---	ns
<b>Q<sub>rr</sub></b>	Reverse Recovery Charge		---	6.7	---	nC

**Notes:**

- 1.The data tested by surface mounted on a 1 inch<sup>2</sup> FR-4 board with 2OZ copper.
- 2.The data tested by pulsed, pulse width ≤ 300us, duty cycle ≤ 2%
- 3.The EAS data shows Max. rating. The test condition is V<sub>DD</sub>=25V, V<sub>GS</sub>=10V, L=0.1mH, I<sub>AS</sub>=21A
- 4.The power dissipation is limited by 150°C junction temperature
- 5.The data is theoretically the same as I<sub>D</sub> and I<sub>DM</sub>, in real applications, should be limited by total power dissipation.

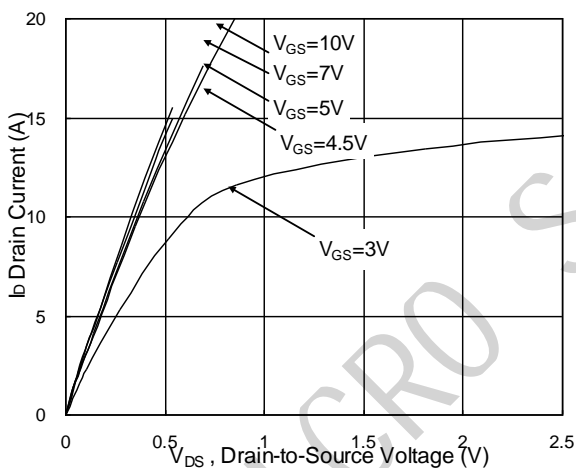
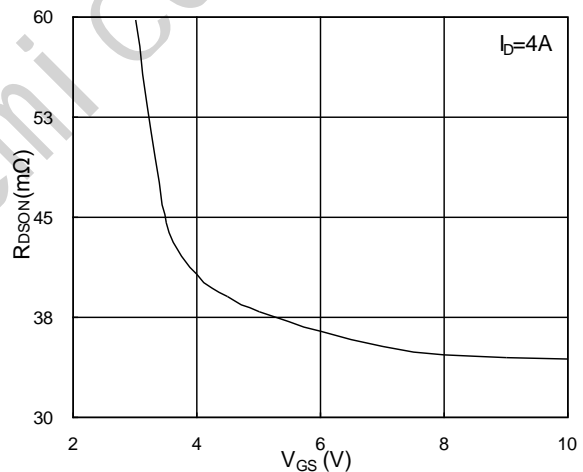
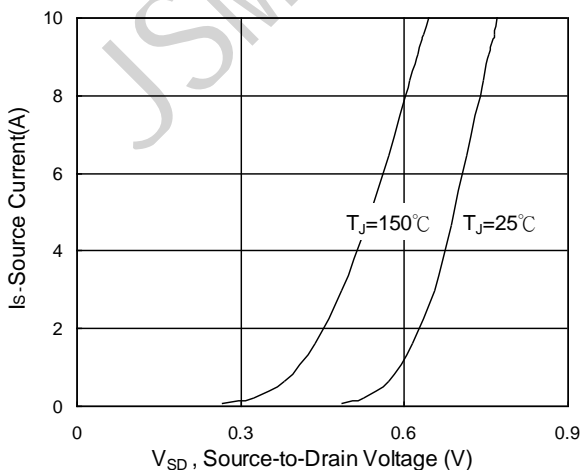
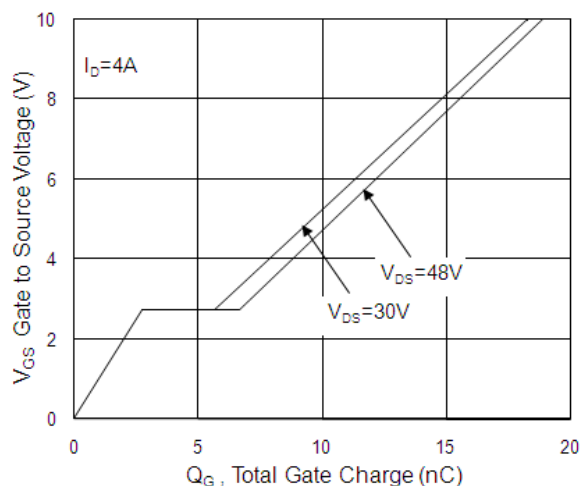
**Typical Characteristics:** (T<sub>C</sub>=25°C unless otherwise noted)

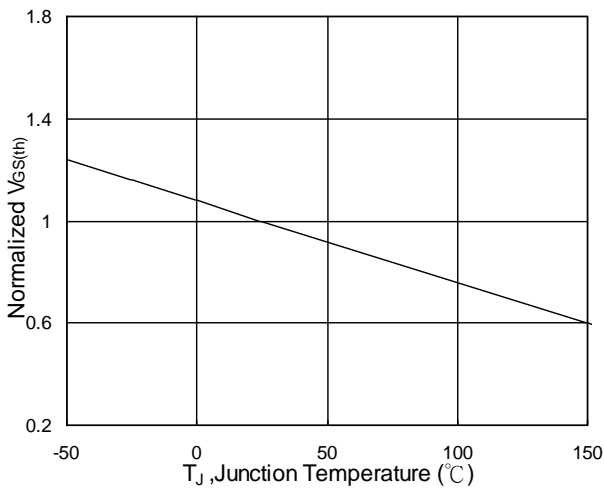
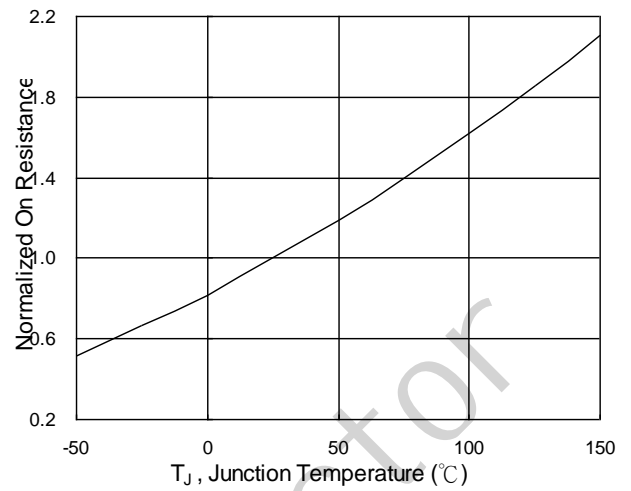
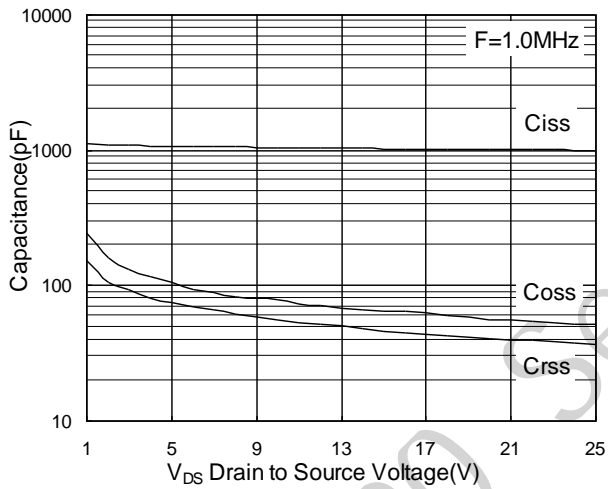
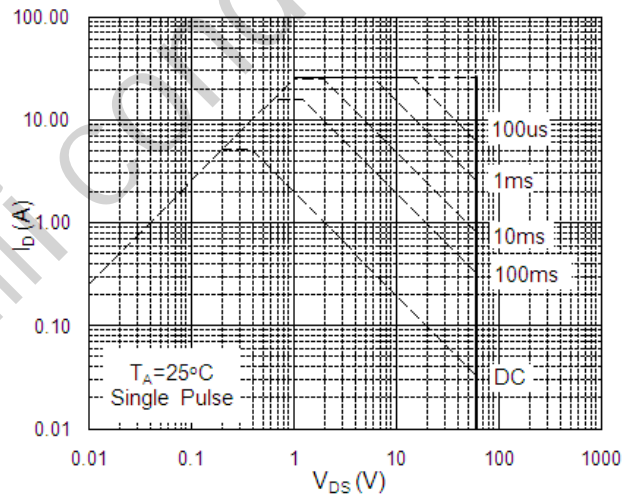
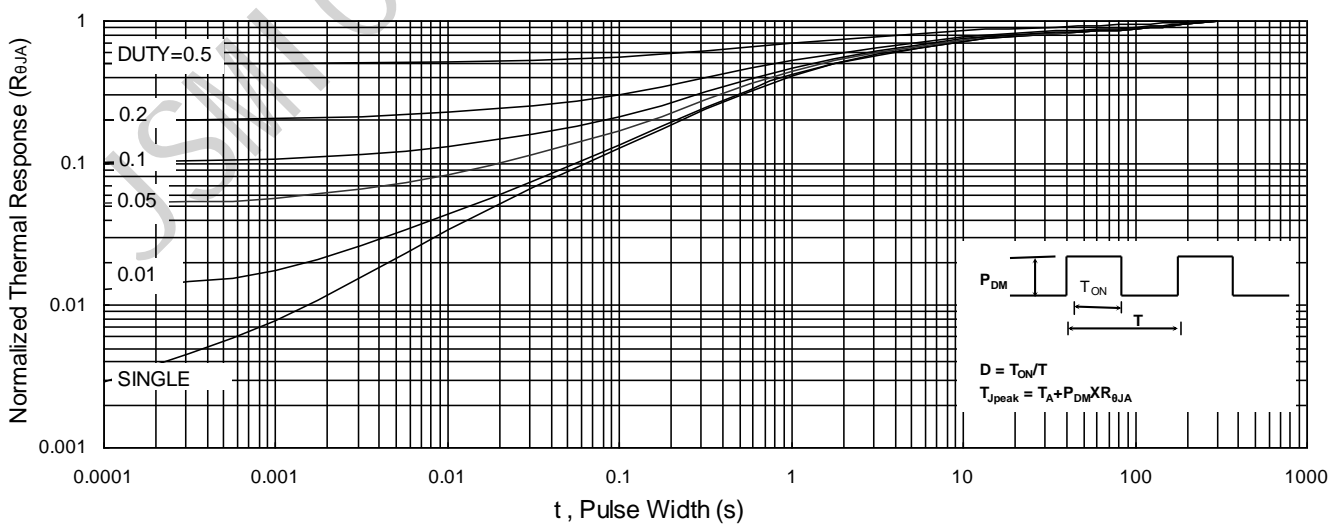
**Fig.1 Typical Output Characteristics**

**Fig.2 On-Resistance vs. Gate-Source**

**Fig.3 Forward Characteristics Of Reverse**

**Fig.4 Gate-Charge Characteristics**

**Fig.5 Normalized  $V_{GS(th)}$  vs.  $T_J$** 

**Fig.6 Normalized  $R_{DS(on)}$  vs.  $T_J$** 

**Fig.7 Capacitance**

**Fig.8 Safe Operating Area**

**Fig.9 Normalized Maximum Transient Thermal Impedance**

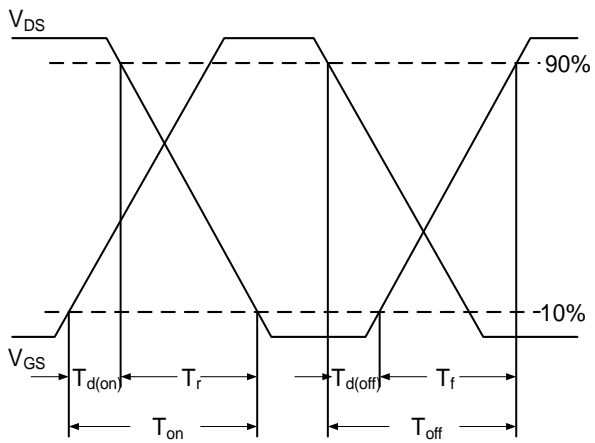

Fig.10 Switching Time Waveform

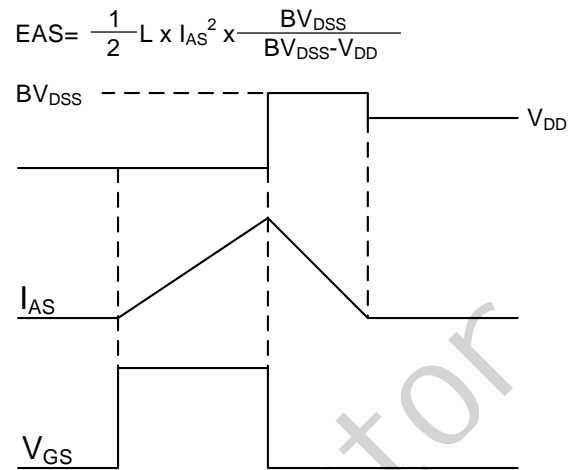
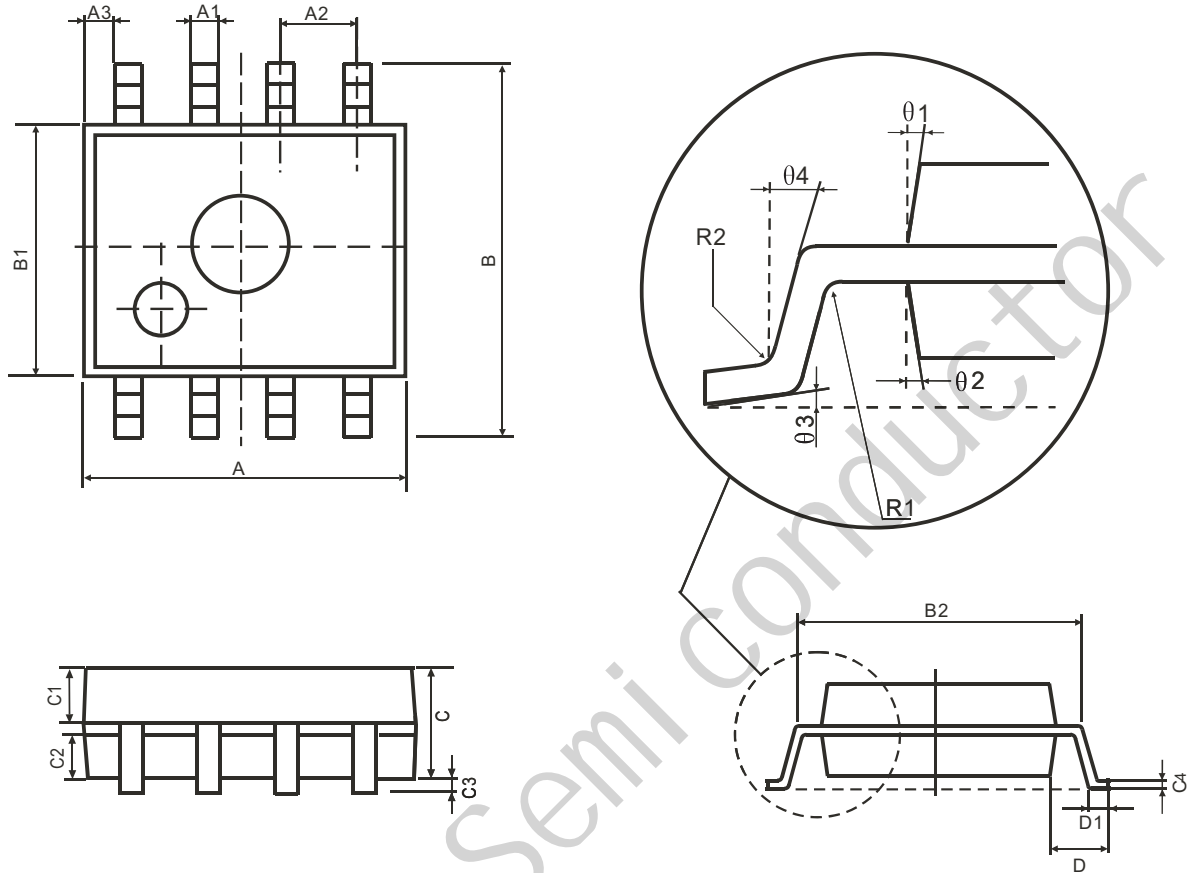

Fig.11 Unclamped Inductive Switching Waveform

封装尺寸  
**SOP8**

符号	尺寸(mm)		符号	尺寸(mm)	
	最小值	最大值		最小值	最大值
A	4.95	5.15	C3	0.05	0.20
A1	0.37	0.47	C4	0.20(典型值)	
A2	1.27(典型值)		D	1.05(典型值)	
A3	0.41(典型值)		D1	0.40	0.60
B	5.80	6.20	R1	0.07(典型值)	
B1	3.80	4.00	R2	0.07(典型值)	
B2	5.0(典型值)		theta1	17°(典型值)	
C	1.30	1.50	theta2	13°(典型值)	
C1	0.55	0.65	theta3	4°(典型值)	
C2	0.55	0.65	theta4	12°(典型值)	